

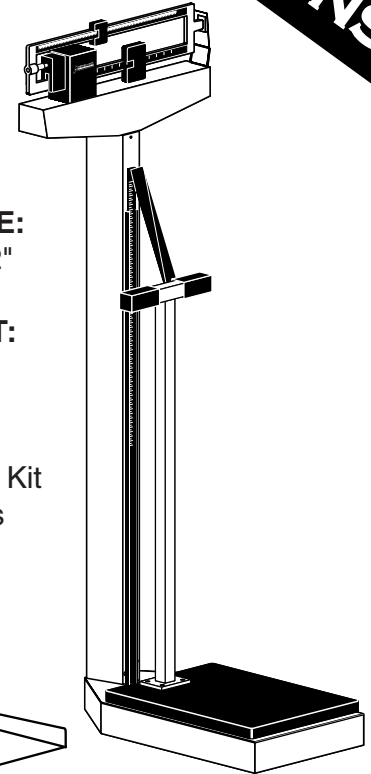

PRODUCT SPECIFICATIONS

Physician Scales

MODELS: 437, 438, 439, 449
2391, 2381, 2491

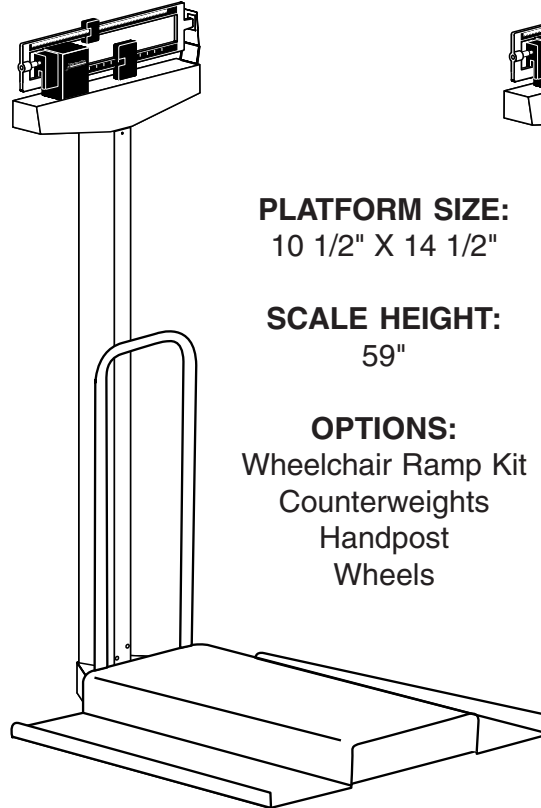
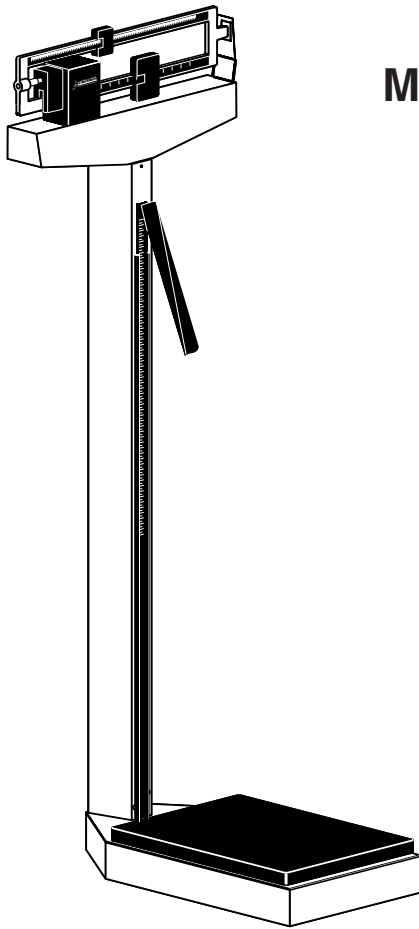

PLATFORM SIZE:
10 1/2" X 14 1/2"

SCALE HEIGHT:
59"

OPTIONS:
Wheelchair Ramp Kit
Counterweights
Handpost
Wheels

Model	Capacity		Height Rod 30-78 in 75-192 cm	Wheels	Handpost	Color	Ship Wt
	350 lb x 4 oz	160 kg x 100 g					
439	☆		☆			White	38 lb
2391		☆	☆			White	37 lb
438	☆		☆	☆		White	39 lb
2381		☆	☆	☆		White	39 lb
449	☆		☆		☆	White	43 lb
2491		☆	☆		☆	White	43 lb
437	☆					White	34 lb

Die-cast beam, aluminum on black insert, easily read from either side

Heavy-duty understructure

Interchangeable parts



Cardinal Scale reserves the right to improve, modify, or enhance features and specifications without prior notice.

