

dual post **order form**

This form is used when ordering the following starting blocks:

- Velocity Dual Post with Trackstart
- Velocity Dual Post w/o Trackstart
- Legacy Dual Post

Help us serve your clients better by including architectural line drawings and specifications for new installations, and line drawings and/or photos for existing applications.

Distributor Information

Date: _____

Company Recreation Supply Company	Contact Name
Phone 1-800-437-8072	Email sales@recsupply.com

Project Job Information

Institution	Contact Name
Address	City, State, Zip
Phone	Email

S.R.Smith manufactures a wide range of starting blocks for use at all levels of competitive swimming, and takes into consideration rules and regulations from the Federation Internationale de Natation (FINA), USA Swimming, National Collegiate Athletic Association (NCAA), National Federation of State High School Associations (NFSH), and the Model Aquatic Health Code (MAHC). S.R.Smith and end user also recognize that state and local building codes apply in various jurisdictions.

Starting blocks are specified in each organization's rules and regulations at various minimum water depths:

- FINA: 4 feet 5 inches
- USA Swimming: 4 feet for competition, 6 feet for teaching, 6 feet 7 inches for championship meets
- NCAA: 4 feet
- NFSH: 4 feet
- MAHC: 4 feet

S.R.Smith takes these minimum water depths into consideration on each order for starting blocks.

With this information, S.R.Smith suggests the following recommendations for maximum starting block height over water:

- Less than 4 feet of water depth: no starting blocks
- 4 feet - 6 feet of water depth: 18 inches
- 6 feet or more of water depth: 29.5 inches

Distributor and End User understand that regulations of governing bodies, including those listed above along with state and local codes, supersede these recommendations when they require additional depth. For example, a pool that will host FINA swim meets cannot place starting blocks in water depths of less than 4 feet 5 inches because it does not meet the minimum depth for FINA. By ordering, purchasing and installing S.R.Smith starting blocks, the Distributor and End User acknowledge receipt and understanding of the above recommendations.

p: 503.266.2231
tf: 800.824.4387
f: 503.266.4334
e: sales@srsmith.com



dual post **order form**

1 – Standard Setback Model (18" to 26")

(circle selected model)

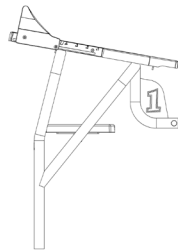

Velocity Dual Post with Track Start

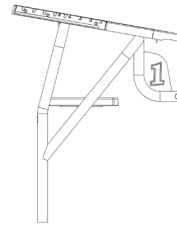

Velocity Dual Post w/o Track Start

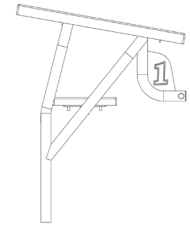

Legacy Dual Post

1 – Long Reach Setback Model (27" to 36")

(circle selected model)

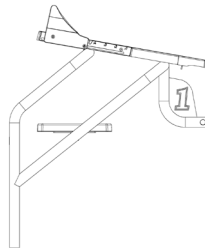

Velocity Dual Post with Track Start

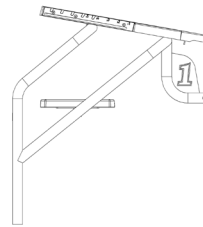

Velocity Dual Post w/o Track Start

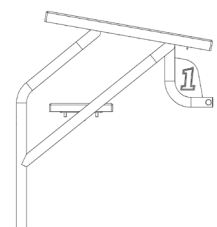

Legacy Dual Post

2 – Dimensions

A – Water Depth

_____ Feet _____ Inches

Please add any additional dimensions (parapet, gutter, etc.) that will affect the design or placement of the starting block to Figure I.

B – Block Height

For water depth greater than 6', the recommended height above water is 29.5". For water depths 4' to 6', the recommended height above water is 18". S.R.Smith does not recommend installing starting blocks on water depths shallower than 4'.

Total height above water (29.5", 18", or a custom height): _____

Deck to water height: _____

Height of block above deck: _____

C – Block Setback

The setback, measured from water's edge to the center of the starting block post (See Figure I), ranges as follows, in one-inch increments:

- Standard 18" to 26"
- Long Reach 27" to 36"

Things to consider are interference from gutters, parapets, and coping. The center point of the anchor should be at least 5" from any edge of the concrete slab.

Setback = _____

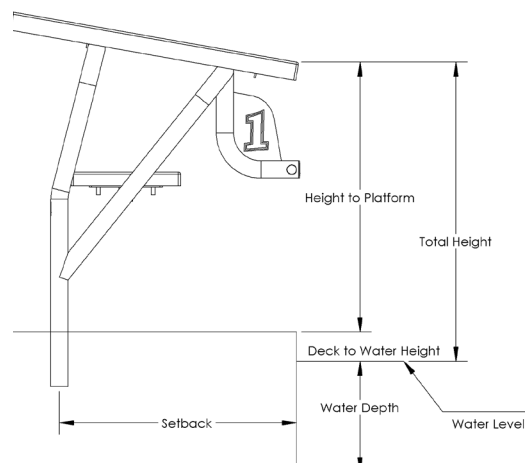

p: 503.266.2231
 tf: 800.824.4387
 f: 503.266.4334
 e: sales@srsmith.com



dual post **order form**

3 – Order Details

A – Quantity

How many blocks would you like to order? _____

B – Frame Color

Standard Color for a Legacy and Velocity is Silver Gray. Other colors are available. There is no fee for any of our standard colors listed in Table I. Place a check next to your desired color or identify a custom color (RAL # is the most accurate way to specify custom colors). *Custom colors will incur additional fees and lead-time.*

FRAME COLOR	
<input type="checkbox"/>	Silver Gray
<input type="checkbox"/>	Royal Blue
<input type="checkbox"/>	Taupe
<input type="checkbox"/>	White

C – Numbering

How would you like the blocks numbered (i.e., 12 starting blocks could be numbered 1-12, two sets of 1-6, or 1-11 with one blank)? _____

TABLE I

D – Anchors

It is possible to have the anchors shipped before the blocks to allow anchor installation prior to delivery of the starting blocks. Notify your salesperson if you would be interested in having the anchors shipped prior to shipping the blocks.

E – Backstroke Handles

The standard backstroke handle is the Horizontal. H-Handle, U-Handle, and Angled configurations are also available. Please check the desired handle. If no option is marked, the Backstroke Horizontal will be used.



Horizontal

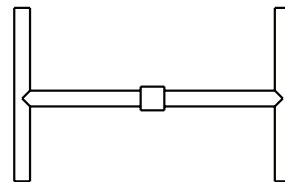

H-Handle

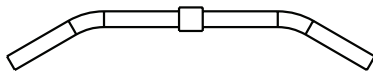

Angled

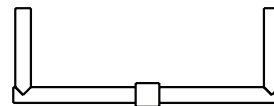

U-Handle

p: 503.266.2231
tf: 800.824.4387
f: 503.266.4334
e: sales@srsmith.com



dual post **order form**

4 – Special Request

Only one of the following choices (A, B, or C) can be selected for your starting block order. These items also include additional charges and lead time.

A – TrueTread™ (Velocity only)

Velocity footboards are available in a choice of four TrueTread™ colors. Place a mark next to the desired color in Table 2.

TRUETREAD™ COLOR
<input type="checkbox"/> Gray
<input type="checkbox"/> Blue
<input type="checkbox"/> Red
<input type="checkbox"/> Yellow

TABLE 2

If you would like a logo or numbering placed on the footboards, please email file in vector-based file or formats. We will send a separate drawing of the logo/numbering placement on the footboard to be signed off along with the drawing for the starting block(s).

- YES, we want a logo.
- YES, we want numbering placed on the footboard.

C – Colored Sand Tread

Note: Colored treads are not available if you have specified a logo or number be placed on the tread.

You can get the tread for the footboard and step in a selection of colors. Place a mark next to the desired color in Table 3. *Standard color for the tread is white. White will be used if there is no color tread or logo selected.*

SAND TREAD COLOR
<input type="checkbox"/> Yellow
<input type="checkbox"/> Red
<input type="checkbox"/> Green
<input type="checkbox"/> Blue

TABLE 3

Distributor and End User understand that regulations of governing bodies, including those listed on Page 1 along with state and local codes, supersede these recommendations when they require additional depth. For example, a pool that will host FINA swim meets cannot place starting blocks in water depths of less than 4 feet 5 inches because it does not meet the minimum depth for FINA. By ordering, purchasing and installing S.R.Smith starting blocks, the Distributor and End User acknowledge receipt and understanding of the above recommendations.

End User Signature	Date
Printed Name	
Distributor Signature	Date
Printed Name	

Return completed and signed form to S.R.Smith:
fax: 503.266.4334 or email: sales@srsmith.com

p: 503.266.2231
tf: 800.824.4387
f: 503.266.4334
e: sales@srsmith.com

